

ROC

Condensing Wall-hung Gas Boiler

USER'S GUIDE



GENERAL NOTICE

- *The user's guide is very important for the product, the user's guide must be kept in user. There are very important instructions for operation and maintenance.*
- *Installation and maintenance must be performed by qualified professional person according to the current rules and instructions of manufacturer.*
- *Manufacturer will not take any responsibility for those person harm and property damage causing by incorrect installation. Gas boiler only use for supplying heating and hot water, can not change to other use.*



WARNING!

Please follow the instruction of user's guide to operate the machine. Manufacturer will not take any responsibility for those person harm and property damage causing by incorrect operation.

Misusage risk warning

- ⚠ **Warning:** Improper installation will cause harm to animals and people.
- ⚠ **Notice:** Machine installation should strictly follow the instruction of user's guide and the relevant provisions.
- ⚠ **Notice:** Only the agents or technicians authorized by our company can repair or replace the components or complete machine.
- ⚠ **Notice:** Original components should be used to avoid the reduction of product security.
- ⚠ **Warning:** Replacing coaxial flue with single pipe flue is prohibited.
- ⚠ **Notice:** Maintenance involving repair of gas pressure regulators and controllers should contact our after-sales service.
- ⚠ **Notice:** You should buy our original products, not buy modified machine from dealer. to ensure the safety.
- ⚠ **Notice:** You should install shut-off valve on the pipe before installing the machine.
- ⚠ **Notice:** The installations of machine should be far away from the stove, microwave ovens and other strong electromagnetic radiation appliances.
- ⚠ **Warning:** Dismantling any seal components on the machine is prohibited.
- ⚠ **Notice:** Machine cleaning should not use corrosive cleaning detergent.
- ⚠ **Warning:** Do not install the machine in the bedroom, living room, or bathroom.
- ⚠ **Danger:** The machine should not be used by children and people who is unable to use it, it is not allowed to let the children play it.
- ⚠ **Notice:** The users should not change their own heating safety valve and relief valve ,should ask professionals for help.
- ⚠ **Notice:** The machine should not be concealed to be installed.
- ⚠ **Must:** The maintenance and inspection personnel should indicate the result on the machine after operating the maintenance and inspection of the product .
- ⚠ **Notice:** The distribution system of room should include ground wire, the machine connection switch should not be set in the room which has bathtub or shower. The plugs, sockets should be certified by the relevant institute.
- ⚠ **Notice:** To avoid the freezing of machine and pipeline, the machine should exhaust the water from heating and D.H.W system when the machine is turned off long time in the winter.



Component name

External structure-component name

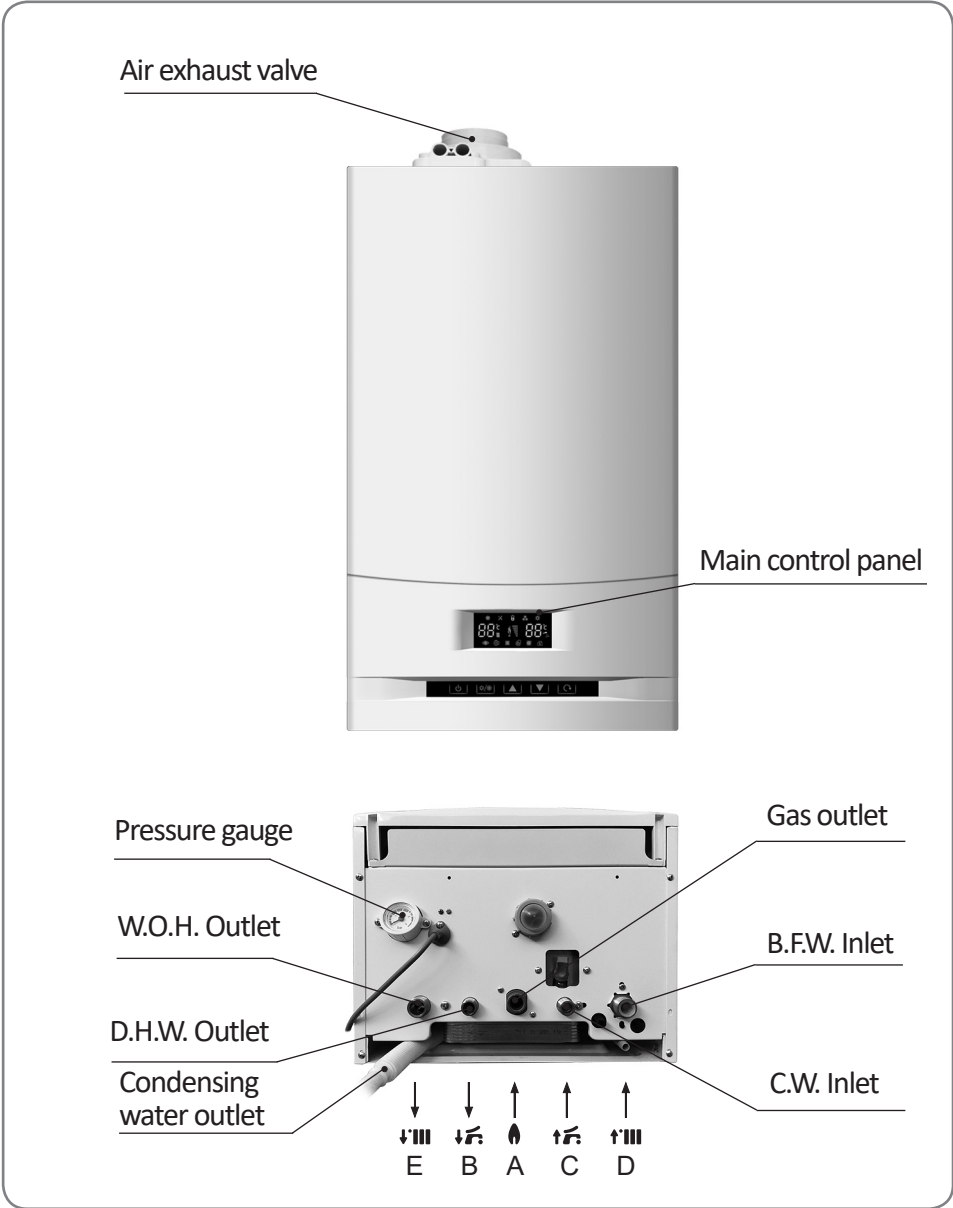



Component name

Inner structure-component name

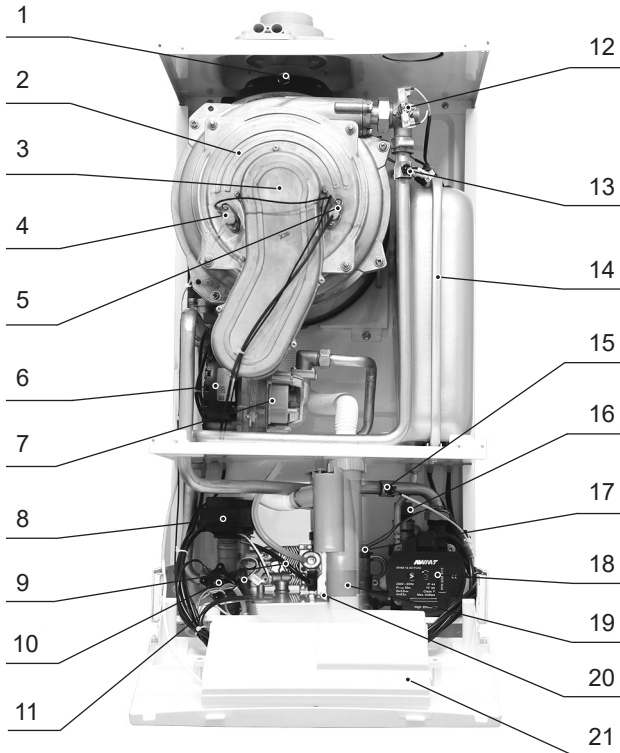

1.Flue gases temperature sensor

2.Heat exchanger

3.Burner

4.Flame detection needle

5. Ignition needle

6.Fan

7.Air-gas mixer

8.Three-way valve motor

9.Plate heat exchanger

10.Water pressure switch

11.Hot water temperature sensor

12.Over heat protector

13.Heating temperature sensor

14.Expansion tank

15.Heating back water temperature sensor

16.Safety pressure relief valve

17. Water flow volume sensor

18.Pump

19.Siphon tube

20.Gas valve

21.Electronic box



Feature of Product

Condensing Heat exchange system

The product uses condensing type heat exchange design.

The tripling circuit coil pipe design absorbs the flue gas heat adequately, efficiency can reach 108%, super low CO and NO_x product. The flue gas temperature can reach 50 °C The condensing result is obvious, green and environmental.

Adopt cuspidate PWM gas proportion control technique

Our key technology is the control system. According to the feedback information from the temperature and pressure sensor. System can accommodate the gas supply volume automatically, control heating and domestic hot water temperature, which is above the temperature you have set so that you can save much energy.

Adopt multiple safe protection device

Our products have the most safe protection device in the same trade. Adopt equilibrium force air exhaust system in which the combustion chamber and air exhaust channels are completely hermetic. It can absorb the fresh air, exhaust the waste air after burning and eliminate the harm of CO for human's body. There are multiple over-heat protection device, protection for flameout, protection for flue building up, protection for over-pressure, multiple protection for preventing frostbite.

Adopt super mute running way

Adopt device for assimilating noise in the burner to assimilate all the noise when burn. At the meantime, with the low-noise excellent fan, circulation pump and flawless hermetic system, all noise will be the least. You will have a peaceful life space.



Feature of product

Adopt international one-up technique

Adopt international one-up automatic adjustment cushion design to reduce the probability of malfunction farthest. This design makes a breakthrough on international heating technology and shows our abundance.

Adopt firm and durable components

First-rate key components ensure the products' quality and usage. Inner material is machined by thermalization and antiseptis, and the panel on which we use special coating with beautiful and elegant colour to improve products' durability and safety.

De-energize performance

If the power breaks when the machine is running, this performance will save all the orders which is saved before the power breaks. it will carry out all the orders automatically as soon as the power works like before.

Microcomputer chip controls and prevents incrustation

Heat exchange system with good quality and prevent-incrustation design connected modern microcomputer chip control temperature for use to delay the incrustation forming.

Exquisite design and simple installation

With exquisite design and compact inner structure, our products are simple to install and maintain. Coaxial supply and exhaust pipe are manufactured according to the product's model so that the installation time will be shortened a lot.



Don't worry! we have safe device as following

Quadruple protection for
overheat

There are four protection devices, preventing over temperature, preventing heating water overheat, preventing domestic hot water overheat, preventing exhausted air overheat. If there is overheat these devices will stop the gas supply automatically and stop working.

The earlier safe ignition
device

For the sake of avoiding deflagration, this device only supply minimum gas in the earlier ignition.

Induction system for
unusual combustion

When there is unusual combustion, the gas supply will be cut automatically.

Device for trash elimination

There are different filter screens in the machine, which can extend the product's life.

Device for preventing
empty-combustion

This device can induce whether there is water leakage in the heating pipe. If there is leakage, combustion will be cut automatically. Machine reruns after pouring the water according to the way to first operation.

Self-diagnoses device

This device can avoid system safety losing control which is caused by protection damage and make sure that the system operates in the safe and reliable environment.

Device for blaze detection

After operation, this device detects the blaze signal anytime and distinguish whether the present working is normal or not.

Safe device for water flow
volume

Detect the water flow volume (super-low water flow protection) to make sure that the machine works safely.

Other safe device

Safe device for preventing flue building up, safe device for refiring, protection for overpressure, automatic safe device for air pressure adjustment, safe device for preventing frostbite, anti-creep age protection, de-energize/water/gas protection and so on. please use it without any worry.



Items for safety

1. Make sure the gas type before use

- Must use the certain gas type and pressure of gas appointed by the label on the machine.
- Forbid to change the gas type willingly. If it is necessary to change, please contact our after-sales service department.

 **Important items for safety!**

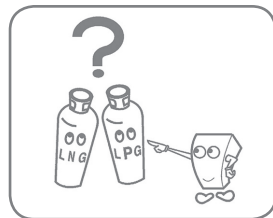

2. Make sure the voltage (220V)

- Voltage is 220V/50hz, alternating current.
- After confirm the voltage, connect the plug. (voltage is required $220V \pm 15\%$. the subscriber had better allocate a manostat if pressure is unstable).

 **Warning:** In order to avoid the risk of leakage, the socket must be connected with a good grounding device.



3. Close the adding water valve after adding water

- After using adding water valve to add water on the heating system, the adding water valve must be closed immediately, otherwise the safety valve will exhaust the water automatically when the pipeline pressure is greater than 3bar. To prevent accidents, please be sure to close the adding water valve.



4. Check the switch for gas before use

- Check the middle switch connected on the gas pipe to see if there is leakage.
- Ensure whether pressure of gas and flow volume of gas supply meet requirement of our product.

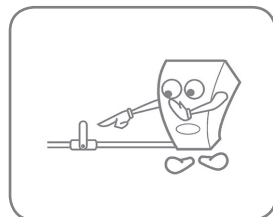

5. Make sure the connecting state of the valve for heating

- Make sure whether the valves for connecting the heater and cooling systems of each room are open or not.
- Parallel—connect pipe could not be operated less than one group cooling valve opening.

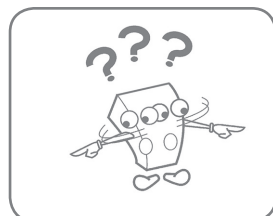



Items for safety

6. Make sure the surrounding environment of the product

- Don't put the product in the place where will be affected by weather. (rain and sunshine).
- Get rid of the combustible and explosive material surrounding the product. It is forbidden to hang clothes to dry on the flue.
- The temperature of flue and water pipe is very high. Be careful, please!

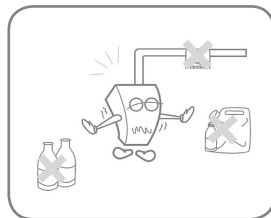

7. Make sure if there is gas leakage

- It is necessary to use soap water to check the gas pipe whether there is gas leakage. (when you put soap water on the gas pipe, if air bubble comes out, that means there is gas leakage.) Ought to close the gas immediately and contact local gas supplier.

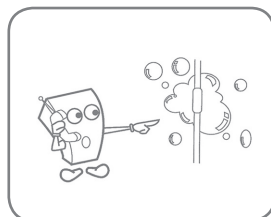

Important safety items!

8. Prevent frostbite in winter

- When heating, heater must be unimpeded. (including water, electricity, gas) There is a prevent-frostbite device in the heater, so the heater will work automatically in low temperature.
- During freezing season or no one at home for a long period, please exhaust the water in the machine and in the heating pipe, cut off the gas supply and pull out the power plug to prevent frostbite.

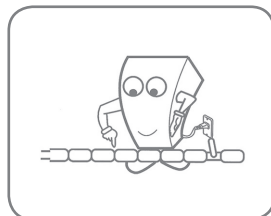

9. Be careful when it fullmines

- Please pull out the power plug when it fullmine so that the heater won't be damaged.

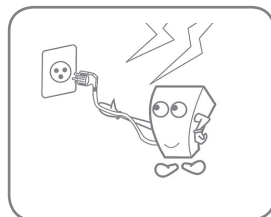

Warning!

- The users should strictly follow the above security warning.
- This product must be assembled, adjusted and maintains regularly by professional people accredited by the manufactory, while the seal configuration is broken, the machine is ban to operate.

FUNCTION AND USE FOR MAIN CONTROL PANEL



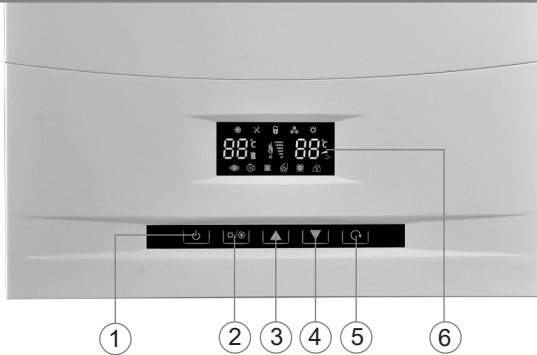



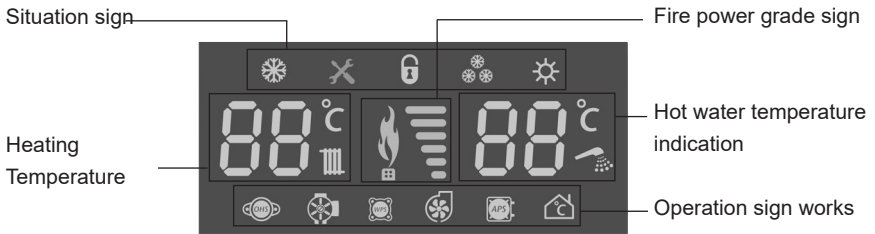

Names For All the Control Panel



1. On/Off (Power) Button
2. Mode Button
3. Up Button
4. Down Button
5. Reset Button
6. Information Indication Display

Display









- | | | | | | |
|---|---|---|---|---|---|
|  |  |  |  | | |
| Winter mode | Malfunction | Anti-freezing | Summer mode | | |
|  |  |  |  |  |  |
| Overheat protector | Pump | Water pressure switch | Fan | Air pressure switch | Room thermostat |



FUNCTION AND USE FOR THE MAIN CONTROL PANEL

Key press on the Main control panel



- **[ON/FF]  button**—Press it five seconds for turning on or off the boiler. After the display is locked, it is Unlock Button. When setting the situation, it is Confirmation Button.
- **[Mode]  /  convert button**—It is Winter/Summer swift Button when the gas boiler is on. It is Set Button when the gas boiler is off.
- **[Up]  button**—Increase the heating and hot water temperature.
- **[Down]  button**—Reduce the heating and hot water temperature.
- **[Reset]  button**—It will reset the malfunction and restart the gas boiler when malfunction occurs. After entering the menu and set the situation, press Reset Button to keep memory and quit the menu.

The method for turning on/off gas boiler

- Press [On/Off]  button for more than five seconds to turn on/off the gas boiler.

How to Set the Heating Temperature

Example: Heating temperature is 55°C

- Under heating condition, press [Up  /Down ] button directly to set the heating outlet water temperature. At this time, the pre-setting temperature flash indicates, then set the temperature to 55°C.
- Under heating state, sanitary hot water has priority.
- The boiler will return to heating state automatically when closing the tap.

How to Set the Temperature of Hot Water

Example: Temperature of hot water is needed 45°C

- Under summer condition, press [Up  /Down ] directly to set the hot water outlet temperature. At this time, the pre-setting temperature flash indicates, then set the temperature to 45°C. (At any time when performing hot water, direct setting is permitted)

FUNCTION AND USE FOR THE MAIN CONTROL PANEL

Malfunction Indication and Maintenance

Malfunction Indication	Code meaning	Malfunction reason
E 1	Flue malfunction	Air pressure or air speed malfunction
E 2	Heating NTC malfunction	NTC open circuit and short circuit
E 3	Shower NTC malfunction	
E 4	Overheat malfunction	When the pipe water temperature is higher than $>93^{\circ}\text{C}$ the overheat switch disconnects
E 5	Gas valve circuit malfunction	The output circuit of the gas valve is abnormal
E 6	Ignition failure	It can not detect the flame
E 7	Fake fire error	Flame detection circuit is out of control
E 8	Back water NTC malfunction	NTC open circuit or short circuit; temperature is over 90°C
E 9	Flue temperature NTC malfunction	
E A	Outside NTC malfunction	NTC open circuit and short circuit
E b	Slash fire malfunction	There is fire after the boiler turns off for 4S
E C	Communication malfunction	The communication is interrupted or disturbed
E P	Pipe malfunction	The water pressure switch is not acted
E E	EEPROM malfunction	EEPROM storage data error
EL	Frequency conversion pump malfunction	Frequency conversion pump malfunction or power capacity is less than 12W
LV	Supply voltage is too low	Supply voltage is lower than 150V
HV	Supply voltage is too high	supply voltage is higher than 270V



First Operation (trial run)

⚠ Special Notice: We recommend user to install and use the air filter device. The air filter will filter out the dust particles in air, to make the air which enter into the full-premix combustion chamber be earlier purified, reduce the malfunction rate and increase the service life.

⚠ Special Notice: We recommend user to use (FERNOX F3) system detergent, before operation, please wash the whole heating system carefully, remove the possible sundries to avoid the system blocked and device damage. (specific operation please check the user's manual of FERNOX F3 system detergent).

⚠ Special Notice: We recommend the user to use (FERNOX TF1) system filter. FERNOX TF1 system filter can effectively clean the magnetic and non-magnetic pollutant in system. (specific operation please check the user's manual of FERNOX TF1 system detergent).

1. Adding water to the heating system

• Turn on the [**water adding valve**] (anti-clockwise direction), at the same time, turn on the vent valve of heating in each room, turn off the vent valve until the water flow out. When the pressure gauge indicator point to 1-1.2bar, turn off the [**water adding valve**] (clockwise direction).



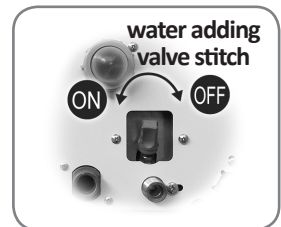

⚠ Attention: The gas boiler supplement water pressure can not be more than 1.2 bar. Please remember that the water adding valve must be turn off after adding water, otherwise the safety pressure relief valve will be turned on to relief the pressure due to the overhigh pressure in heating system. In order to avoid the unnecessary property loss, please connect a water pipe from the safety valve outlet to floor drainage.





⚠ Attention: We recommends user to use (FERNOX F1) system protective agent, add the system protective agent into the pipeline after the water adding is finished. The concentration of system protective agent should be around 0.5%. After adding the system protective agent, please add the protective agent detected package to test the concentration of system protective agent. (specific operation please check the user's manual of FERNOX F1 system protective agent).

First Operation (trial run)

2. Operation

1) Plug in to reach power, and then open the gas valve. Press [ON/OFF]  to start the boiler, at the mean time, circulation pump works automatically to exhaust air in heating system, check in the panel if the pressure drops, if the pressure is less than 0.7bar, pour water again(the way to pour water is the same as above). When the pressure reaches balance, press [Mode]  button to make sure the system works under the winter mode (winter mode  is showed in display), when the system convert to normal state, it will ignite and burn automatically. Press [Up  / Down ] button to adjust the heating water temperature, the range is from 30-80°C, floor heating is from 30-65°C.

2) When you open the water tap to use sanitary hot water, press [Up  /Down ] to adjust the hot water temperature(range is from 30-55°C). The speed of water output depends on the length of the pipe. After all cold water flows out, hot water will flow out.

3. Finish operation

- The trial run can finish and enter the normal operation after adjusting to comfort temperature.
- The gas boiler may lack of water after the long time operation, when the pressure indicated on pressure gauge is lower than the above value, you can supplement water according to above method. (It would be the best that the indicator on pressure gauge points at 1-1.2bar)

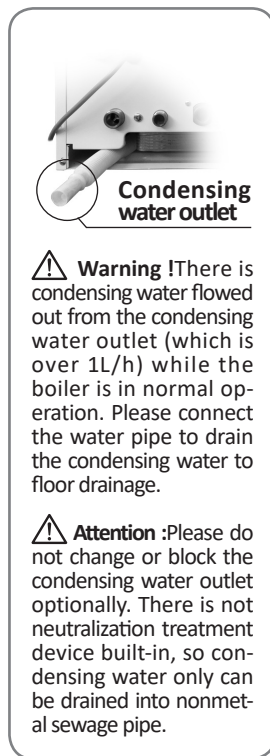

 **Warning!** The first operation of gas boiler should be done after the installation and qualified examination.

 **Attention:** Due to the reason such as installation area or environment etc, the safety pressure relief valve may flow out few water automatically during the normal operation, this is caused by the heat expansion of water inside the circle pipe. A plastic pipe can be connected to the pressure relief outlet to drain the water, or appropriate controlled the water pressure when adding water.



Turn on/off the machine correctly, Cleaning and maintenance of Product

1.Start boiler

- If restarting the gas boiler after the gas boiler turns off, observe the pressure gauge firstly. If it is less than 0.7 bar, please pour the water again according to the pouring way in page “First Operation”. Plug in and connect the power and gas, turn on the gas boiler according to the operation way in page first operation after pouring the water again. (the pressure is between 1-1.2 bar,)

2.Not be used for short Period

- Gas boiler needs to be off if it won't be used for a short period. Press  and then the machine turns off. When the gas boiler is under OFF state, please keep the current and gas supply. Gas boiler will run according to self-protection program.

3.Long period shutdown

- The gas boiler needs to be turned off if it won't be used for a long period. Press  button and the machine will turn off. Cut the current and gas supply, close the gas switches and valves for heating/domestic hot water system. For preventing frostbite, exhaust all the water in the boiler (heating and domestic hot water) and in the heating pipe, close the boiler's gas valve and pluck the plug.

4. Cleaning and Maintenance

- Gas boiler must be cleaned and maintained more than one time per year. If over one year, the trash in each pipe will make the performance debase and make some noise, which becomes the reason for malfunction. If it happens, please contact our after-sales service department and clean the boiler under the skilled man's direction. (cleaning and maintenance must be before the heating period).

 **Attention:** recommend the user to sign the cleaning and maintenance contact with your regional technician who is authorized by our company.

Maintenance	Check once a year	Check once for two years
Check the obturator	✓	✓
Clean the heat exchanger and the flue	✓	✓
Clean the combustion chamber, fan and venturi pipe	✓	✓
Check the device for electricity and gas	✓	✓
Check the gas flow volume and pressure	✓	✓
Check all the ventilation and smoke	✓	✓
Clean the burner and exam the ignition function	✓	✓
Check the water system	✓	✓
Analyze the combustion state	-	✓
Check the lubrication of components	-	✓
Check the tightness of gas device	-	✓
Clean the secondary heat exchanger	-	✓
Check the performance of electricity and electronic components	-	✓
Volume and speed of the fan	-	✓

Attention: ✓ necessary, - not necessary.

▶ Make sure the following items before repairing

Abnormal Phenomenon	Abnormal Reasons	Maintenance Way
There is gas smell	Close the mid-valve connected with gas pipe. Don't turn on or off the electrical equipments and then ventilate. Contact the supplier or the local after-sales service department to repair quickly. Use the suds regularly to make sure whether there is gas leakage on the connection of the gas pipe.	
It can't ignite	Does the fuse break? Does the electrical source work normally? Does the gas supply normally?	Change a new fuse(250V/3A). Check the outer electric circuit. Open the mid-valve, if the gas is used up (provided you LPG usage state), please replace the gas tank.
There is some unusual noise during start process.	Are the air supply and exhaust tube blocked? Is the heating pipe unimpeded?	Please refer to the installation guide, examine the heating pipe and mid-valve.
There is smoke smell	Is the installation for the air supply and exhaust pipe correct? Are there some gaps on the smoke pipe? Is the blaze normal? (Is there yellow blaze?)	Please refer to the installation guide. Please mend the gap. Clean and maintain more than one time per year.
Bad heating effect	Is the function selection under D.H.W mode? If the heating pipeline is blocked? Is the distributionvalve for radiator open? Is the heating temperature set too low? Is there air in the radiator?	Please adjust to heating mode. Please exam the heating pipe and mid-valve. Please compare each room's acreage firstly and compare the open state of valves for the distributors. Please set suitable temperature. Please exhaust all the air in the pipe.
There is no hot water (or hot water isn't hot)	Is the temperature set too low? Are there several places using water at the same time? Is there leakage in the hot water pipe? Is the water supply pressure too low? Does the valve for water supply close?	Please adjust to suitable temperature. Please close excessive hot water taps. Please mend the places where leak water. Please take some measures (such as adding a raise-pressure pump) when the water pressure is less than 0.02MPa(0.2bar). Please open the valve for water supply.

Notice: If the above malfunction remain after the inspection, excluding and restart, please contact with the after-sales service.



Technical data

Model		LL1GBQ24-B26CN	LL1GBQ28-B30CN	LL1GBQ35-B37CN
Gas boiler type	-	Domestic condensing gas boiler		
Capacity				
Nominal heat input (Qn)	kW	24.4	28.4	35.0
Nominal heat output (Pn)	kW	24.0	28.0	33.6
Nominal condensing output (50/30°C)	kW	26.0	30.0	37.0
Minimum heat input (Qr)	kW	5.0	5.5	5.8
Minimum heat output (Pr)	kW	5.0	5.3	5.6
Efficiency				
Normal heat efficiency (80/60°C)	%	99	99	99
Normal heat efficiency (50/30°C)	%	108	108	108
Heat efficiency of 30% capacity	%	108	108	108
Technical data				
Normal capacity gas consumption volume (NG)	kg/h	2.6	3.0	3.7
Flue gas temperature (NG)	°C	69	69	69
Anti-frost protection system start temperature	°C	5	5	5
Minimum domestic hot water volume	kg/min	2.5	2.5	2.5
Sanitary water maximum pressure	MPa	0.8	0.8	0.8
Sanitary water minimum pressure	MPa	0.02	0.02	0.02
Expansion tank capacity	L	6.5	8.0	8.0
Expansion tank preset pressure	MPa	0.1	0.1	0.1
Heating system maximum pressure	MPa	0.3	0.3	0.3
NG normal pressure	KPa	2.0	2.0	2.0
Performance				
Heating water maximum temperature	°C	80-30	80-30	80-30
Hot water maximum temperature	°C	60-30	60-30	60-30
Hot water rate ($\Delta t=25^{\circ}\text{C}$)	kg/min	13.4	15.6	19.2
Electric circuit				
Supply voltage/frequency	V~/Hz	220/50	220/50	220/50
Input electric power	W	110/130	120/130	130/150
Protection level		IPX4D	IPX4D	IPX4D



Product appearance diemnsion and pipe connection position

Unit:mm

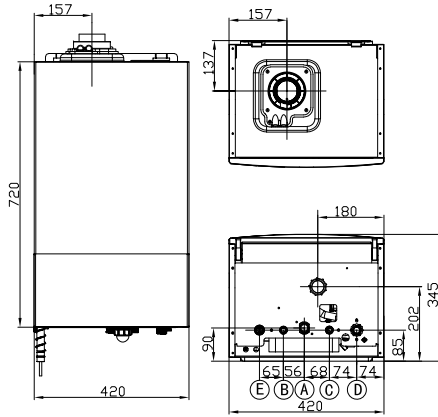

LL1GBQ24-B26CN
LL1GBQ28-B30CN

- A.Gas
- B. D.H.W
- C.Cold water
- D.Heating back water
- E.Heating water

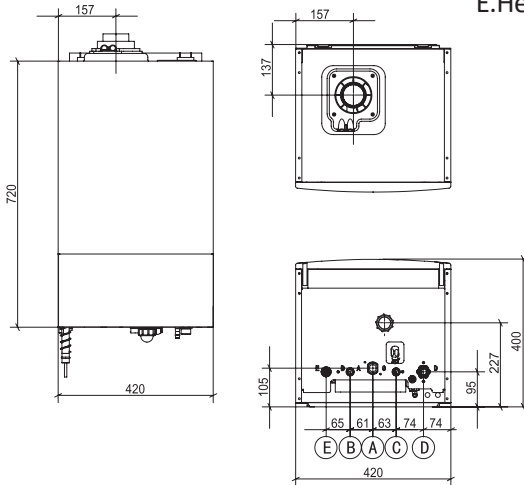

LL1GBQ35-B37CN



Appendix

Complete equipment package list

Main body carton

- Main body

Installation package

- 1 pc product hung plate
- Six angle cross tapping screws

Flue pipe carton

- 1 pc condensing smoke pie
- 1 pc 90° coaxial elbow

Accessory bag

- 1 pc user's guide

Notice:

Due to the improvement of the product, some contents and illustrations in this manual may not be completely consistent with the product without prior notice. please understand that the product specification shall be subject to the product nameplate.

