

ROC

USER'S GUIDE

Wall-hung Gas Boiler

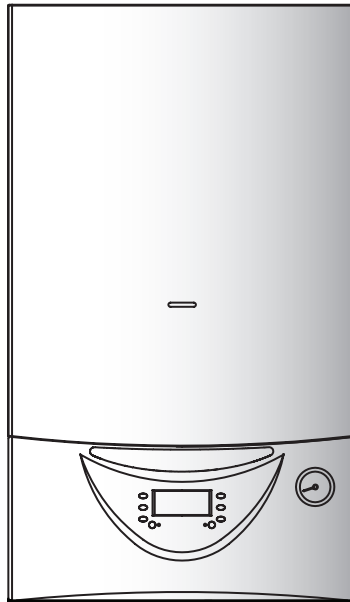

GENERAL NOTICE

- *The user's guide is very important for the product, the user's guide must be kept in user. There are very important instructions for operation and maintenance.*
- *Installation and maintenance must be performed by qualified professional person according to the current rules and instructions of manufacturer.*
- *Manufacturer will not take any responsibility for those person harm and property damage causing by incorrect installation. Gas boiler only use for supplying heating and hot water, can not change to other use.*



WARNING!

Please follow the instruction of user's guide to operate the machine. Manufacturer will not take any responsibility for those person harm and property damage causing by incorrect operation.

CONTENTS

- 4 Feature of product
- 6 Don't worry! We have safe device as follows
- 7 Items for safety
- 9 Function and use for main control panel
- 12 First operation
- 14 Turn on/off the machine correctly
- 15 Cleaning and maintenance
- 16 Make sure the following items before repairing
- 17 Technical data
- 18 Appearance and dimension

APPENDIX: Packing List in A Whole Unit



FEATURE OF PRODUCT

1. Adopt heat exchanger system with high efficiency and energy saving

Adopt fine copper heat exchanger with good quality and NO_x burner, which can increase burning rate, save the energy and protect the environment. They have two excellent functions, heating with high efficiency and supply hot water with super-large capability.

2. Adopt cuspidate PWM gas proportion control technique.

Our key technology is the control system. According to the feedback information from the temperature and pressure sensor, system can accommodate the gas supply volume automatically, control heating and domestic hot water temperature, which is above the temperature you have set so that you can save much energy.

3. Adopt multiple safe protection device

Our products have the most safe protection device in the same trade. Adopt equilibrium force air exhaust system in which the combustion chamber and air exhaust channels are completely hermetic. It can absorb the fresh air, exhaust the waste air after burning and eliminate the harm of CO for human's body. There are multiple over-heat protection device, protection for flameout, protection for flue building up, protection for over-pressure, multiple protection for preventing frostbite.

4. Adopt super mute running way

Adopt device for assimilating noise in the burner to assimilate all the noise when burn. At the meantime, with the low-noise excellent fan, circulation pump and flawless hermetic system, all noise will be the least. You will have a peaceful life space.



FEATURE OF PRODUCT

5. Adopt international one-up technique

Adopt international one-up automatic adjustment cushion design to reduce the probability of malfunction farthest. This design makes a breakthrough on international heating technology and shows our abundance.

6. Adopt firm and durable components

First-rate key components ensure the products' quality and usage. Inner material is machined by thermalization and antiseptis, and the panel on which we use special coating with beautiful and elegant colour to improve products' durability and safety.

7. De-energize performance

If the power breaks when the machine is running, this performance will save all the orders which is saved before the power breaks. it will carry out all the orders automatically as soon as the power works like before.

8. Microcomputer chip controls and prevents incrustation

Heat exchange system with good quality and prevent-incrustation design connected modern microcomputer chip control temperature for use to delay the incrustation forming.

9. Exquisite design and simple installation

With exquisite design and compact inner structure, our products are simple to install and maintain. Coaxial supply and exhaust pipe are manufactured according to the product's model so that the installation time will be shortened a lot.



DON'T WORRY! WE HAVE SAFE DEVICE AS FOLLOWS

1. Treble protection for overheating

There are three protection devices, preventing over temperature, preventing heating water over heat, prevent domestic hot water over heat. If there is overheating these devices will stop the gas supply and working.

2. The earlier safe ignition device

For the sake of avoiding deflagration, this device only supply minimum gas in the earlier ignition.

3. Induction system for unusual combustion

When there is unusual combustion, the gas supply will be cut automatically.

4. Device for trash elimination

There are different filter screens in the machine, which can extend the product's life.

5. Device for preventing empty-combustion

This device can induce whether there is water leakage in the heating pipe. If there is leakage, combustion will be cut automatically. Machine reruns after pouring the water according to the way to first operation.

6. Self-diagnoses device

This device can avoid system safety losing control which is caused by protection damage and make sure that the system operates in the safe and reliable environment.

7. Device for blaze detection

After operation, this device detects the blaze signal any time and distinguish whether the present working is normal or not.

8. Safe device for water flow volume

Detect the water flow volume (super-low water flow protection) to make sure that the machine works safely.

9. Other safe device

Safe device for preventing flue building up, safe device for refiring, protection for overpressure, automatic safe device for air pressure adjustment, safe device for preventing frostbite, anti-creepage protection, de-energize/water/gas protection and so on.. please use it without any worry.



ITEMS FOR SAFETY

1. Make sure the gas type before use

- Must use the certain gas type and pressure of gas appointed by the label on the machine.
- Forbid to change the gas type willingly. If it is necessary to change, please contact our after-sales service department.

Important items for safety!

2. Make sure the voltage (220V)

- Voltage is 220V/50hz, alternating current.
- After confirm the voltage, connect the plug. (voltage is required $220V \pm 15\%$. the subscriber had better allocate a manostat if pressure is unstable.

 **Warning!** In order to avoid the risk of leakage, the socket used in connection with this product must have a good grounding device.

3. The water filling valve must be closed after adding water.

- When adding water to the heating system with the water filling valve, the water pressure is increased to between 1-1.2bar, the water filling valve must be closed immediately, otherwise when the water pressure in the pipeline is greater than 3bar, the safety valve will automatically drain. To prevent accidents, be sure to close the water filling valve.

4. Check the switch for gas before use

- Check the middle switch connected on the gas pipe to see if there is leakage.
- Ensure whether pressure of gas and flow volume of gas supply meet requirement of our product.

5. Make sure the connecting state of the valve for heating.

- Make sure whether the valves for connecting the heater and cooling systems of each room are open or not.
- Parallel—connect pipe could not be operated less than one group cooling valve opening.

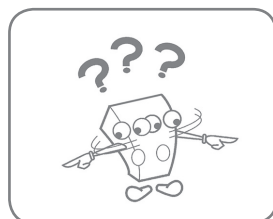
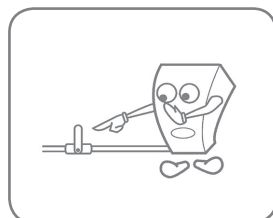
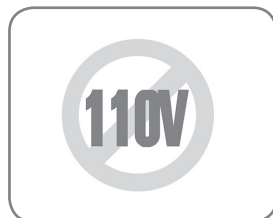
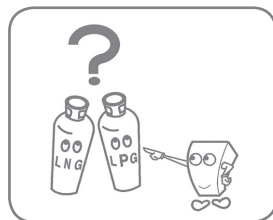



ITEMS FOR SAFETY

6. *Make sure the surrounding environment of the product*

- Make sure the surrounding environment of the product. Get rid of the combustible and explosive material surrounding the product. It is forbidden to hang clothes to dry on the flue.
- The temperature of flue and water pipe is very high. Be careful, please!
- Please do not directly touch the fire hole during use to avoid burns.

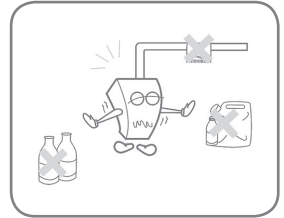

7. *Make sure if there is gas leakage*

- It is necessary to use soap water to check the gas pipe whether there is gas leakage. (when you put soap water on the gas pipe, if air bubble comes out, that means there is gas leakage.) Ought to close the gas immediately and contact local gas supplier.

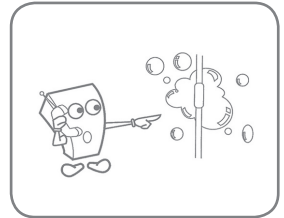

Important items for safety!

8. *Prevent frostbite in winter*

- When heating, heater must be unimpeded. (including water, electricity, gas) There is a prevent-frostbite device in the heater, so the heater will work automatically in low temperature.
- During freezing season or no one at home for a long period, please exhaust the water in the machine and in the heating pipe, cut off the gas supply and pull out the power plug to prevent frostbite.

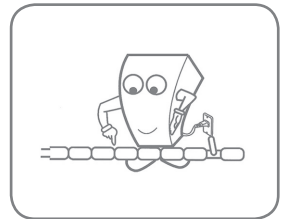

9. *Be careful when it fullmines*

- Please pull out the power plug when it fullmine so that the heater won't be damaged.

Warning!

- Users should strictly observe the above safety warnings.
- This product must be installed, debugged and regular maintenance by professionals authorized by the manufacturer. All locking devices cannot be adjusted at will, and it is strictly forbidden to operate the boiler when the seal structure is damaged.

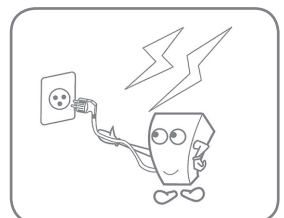



FUNCTION AND USE FOR MAIN CONTROL PANEL

Names For All the Control Panel

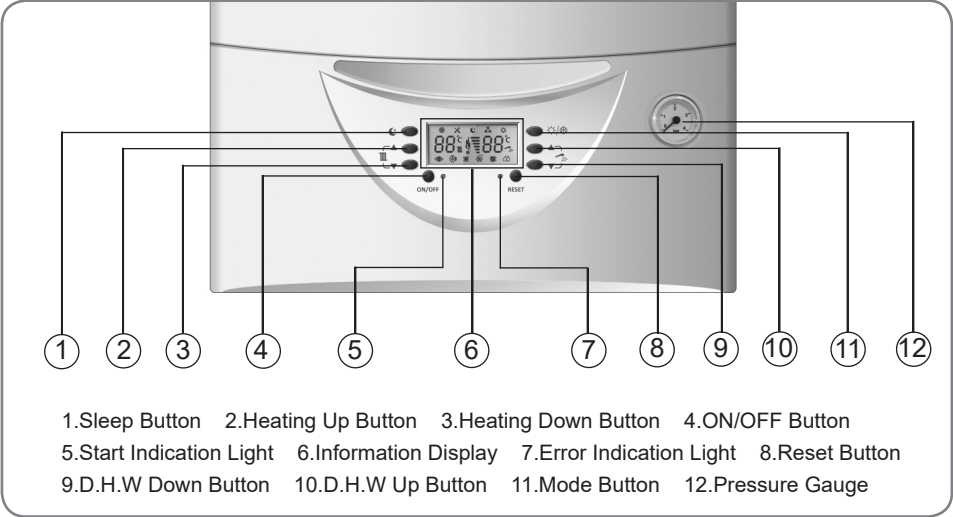



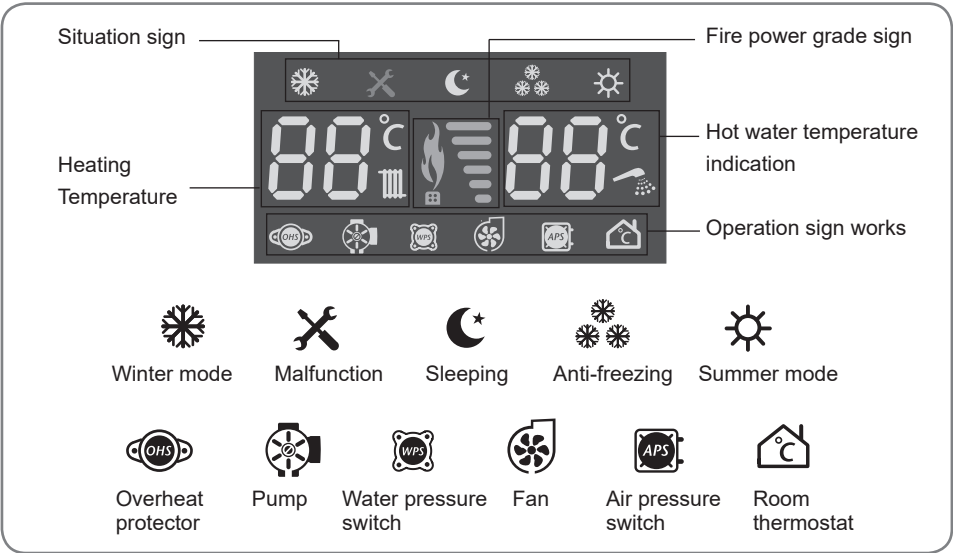



Icon Meaning





FUNCTION AND USE FOR THE MAIN CONTROL PANEL

Key press on the Main control panel

- **[ON/FF] ON/OFF button**—Controls gas boiler be on or off, it is taken as confirmation button when setting the status.
- **[Reset]  button**— Restart the gas boiler when there is malfunction.
- **[Sleep]  button**— After running 1 hour at the setting temperature, it decreases to the 80% temperature status of pre-setting temperature, keeps the most comfortable sleep temperature.
- **[Mode]   convert button**— On status is Winter/Summer switch button, when in off status,press 5 second is Set button.
- **CH  [Up▲ / Down ▼] button**— To set CH temperature.
- **D.H.W  [Up▲ / Down ▼] button**— To set D.H.W temperature.

How to Set the Heating Temperature

Example:Heating temperature is 55°C

- Under heating condition, press  [Up ▲ /Down ▼] button directly to set the heating outlet water temperature.At this time, the pre-setting temperature flash indicates, then set the temperature to 55°C.
- Under heating state, sanitary hot water has priority.
- The boiler will return to heating state automatically when closing the tap.

How to Set the Temperature of Hot Water

Example:Temperature of hot water is needed 45°C

- Under summer condition, press  [Up ▲ /Down ▼] directly to set the hot water outlet temperature. At this time, the pre-setting temperature flash indicates, then set the temperature to 45°C. (At any time when performing hot water, direct setting is permitted)

LED Indication

- **.Green** - Machine is returned on.
- **.Red** - Malfunction. (shine for a long time when the ignition fails and flash on and off when other malfunction comes out)



FUNCTION AND USE FOR THE MAIN CONTROL PANEL

Malfunction Display And Maintain

Malfunction display	Code Meaning	Malfunction Reason
E1	Flue malfunction	The malfunction of air pressure or air speed.
E2	Heating NTC malfunction	NTC open circuit and short circuit.
E3	Hot water NTC malfunction	NTC open circuit and short circuit.
E4	NTC overheat malfunction	The pipe water temperature is higher than 93 degree.
E5	Gas valve's circuit malfunction	The output circuit of the gas valve is abnormal.
E6	Ignition failure	Can not detect the flame.
E7	Fake fire malfunction	Flame detect circuit is out of control.
Eb	Slash fire malfunction	There is fire after the boiler turns off four seconds.
EC	Communication malfunction	The communication is interrupted or disturbed.
EP	Pipe malfunction	The water pressure switch is not acted.

FIRST OPERATON

1.Pour Water For the Heating System

1) Open the pouring water valve (anti-clockwise) and each air exhausted valve until water comes out, then close the air exhausted valve. When screen indicates the pressure to 1-1.2bar, close the water pouring valve.

Notice: The pressure of pouring water can't exceed 1.2bar, the water pouring valve should be closed immediately after filling water, or else safety valve of heating system will open automatically because of over high pressure. To avoid any property loss, please connect a water pipe to the safety valve to the floor drain.

2.Operation

1) Plug in to reach power, and then open the gas valve. Press [ON/OFF] to start the boiler, at the mean time, circulation pump works automatically to exhaust air in heating system, check in the panel if the pressure drops, if the pressure is less than 0.7bar, pour water again(the way to pour water is the same as above). When the pressure reaches balance, press [Mode] ☀️/❄️ convert button to make sure the system works under the winter mode (screen indicates winter icon), when the system convert to normal state, it will ignite and burn automatically. Press [Up ▲ /Down ▼] button to adjust the heating water temperature, the range is from 30-80°C, floor heating is from 30-65°C.

2) When you open the water tap to use sanitary hot water, press [Up ▲ /Down ▼] to adjust the hot water temperature(range is from 30-55°C). The speed of water output depends on the length of the pipe. After all cold water flows out, hot water will flow out.

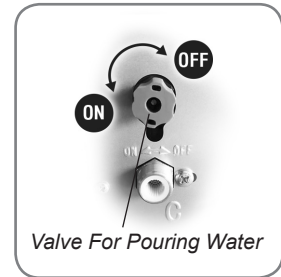
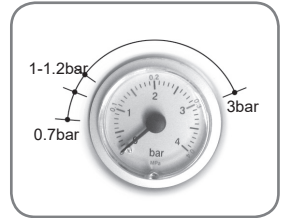



FIRST OPERATON

3. Finish the Operation

- 1) Set to suitable temperature, the first operation is finished and the boiler starts to work normally
- 2) The boiler will be lack of water after long time operation, when the pressure indication in screen is below above data, it is necessary to pour water again using above method.(The best pressure indicated in panel is between 1-1.2bar)

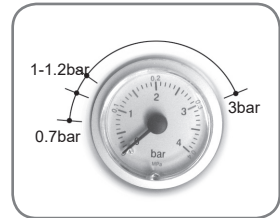

Attention:

The first operation must be after the boilers installation and eligible examination.

Because of installing acreage or environment factors, valve for decompression may drain some water automatically. That is the reason that water in circulator has thermal expansion. To connect a rubber duct with the interface of the thermal expansion is the best way to exhaust the water or control the water pressure properly while pouring water.



TURN ON/OFF THE MACHINE CORRECTLY

1. Turn on the Gas Boiler

If restart the gas boiler, pay attention to the pressure gauge firstly. If it is less than 0.7bar, please pour the water again according to the pouring way in page “first operation”. Plug in and connect the power and gas to turn on the gas boiler according to the operating way in page first operation after pouring the water again. (pressure between 1-1.2bar)

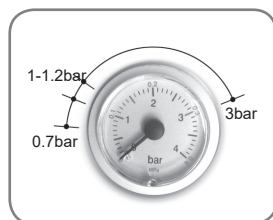

2. Not Be Used For A Short Period

Gas boiler needs to be off if it won't be used for a short period. Press **ON/OFF** and then the machine turns off. When the gas boiler is under OFF state, please keep electricity and gas supply, boiler will carry out self-protection program automatically.

3. Not Be Used For A Long Period

Gas boiler needs to be off if it won't be used for a long period. Press **ON/OFF** and then the machine turns off. Cur electricity and gas supply, close gas switch and valves for D.H.W. system and heating system. To prevent freeze, must exhaust up all water inside of D.H.W. system and heating system.

CLEANING AND MAINTENANCE

4. Cleaning And Maintain

Gas boiler must be cleaned and maintained more than one time per year. If over one year, the trash in each pipe will make the performance debase and make some noise, which becomes the reason for malfunction. If it happens, please contact our after-sales service department and clean the boiler under the skilled man's direction. (Cleaning and maintenance must be before the heating period)

Maintenance	Check on time once a year	Check on time twice a year
Check the obturator	✓	✓
Clean the heat exchanger beyond the flue	✓	✓
Clean the combustion chamber, fan and inner pipe	✓	✓
Check the device for electricity and gas	✓	✓
Check the gas flow volume and pressure	✓	✓
Check all the smoke pipes	✓	✓
Clean the burner and exam the fire performance	✓	✓
Check the water system	✓	✓
Analyze combustion state	–	✓
Check the lubrication of components	–	✓
Check the tightness of gas device	–	✓
Clean the quadric heat exchanger	–	✓
Check the performance of electric and electronic components	–	✓
Volume and speed of the fan	–	✓

Attention: ✓ necessary, - not necessary.

Attention: When cleaning and maintenance, don't damage the sealed construction of product and accessories.



MAKE SURE THE FOLLOWING ITEMS BEFORE REPAIRING

<i>Abnormal Occurrence</i>	<i>Abnormal Reasons</i>	<i>Way to Maintain</i>
<i>A gas smell</i>	Close the mid-valve connected by gas pipe. Don't turn on or off the electrical equipments and then ventilate. Contact the supplier or the local after-sales service department to make it repaired. Use the suds termly to make sure whether there is gas leakage on the connection of the gas pipe.	Close the mid-valve connected by gas pipe. Don't turn on or off the electrical equipments and then ventilate. Contact the supplier or the local after-sales service department to make it repaired. Use the suds termly to make sure whether there is gas leakage on the connection of the gas pipe.
<i>Can't ignite</i>	Does the fuse break? Does the electrical source work normally? Does the gas supply normally?	Change a new fuse(250V/3A). Check the outer electric circuit. Open the mid-valve, and if the gas is used up (provided you use LPG), please refill.
<i>Some unusual noise when start</i>	Are the air supply tube and smoke pipe built up? Is the heating pipe unimpeded?	Please consult installing guider. Please exam the heating pipe and mid-valve.
<i>A smoke smell</i>	Is the installation for the air supply tube and smoke pipe correct? Are there some gaps on the smoke pipe? Is the blaze normal? (Is there yellow blaze)	Please consult installing guider. Please mend the gap. Clean and maintain more than one time per year.
<i>Bad heating effect</i>	Is the distributing valve for radiation open? Is the heating temperature set too low? Is there air in the radiator?	Please adjust to heating mode. Please exam the heating pipe and mid-valve. Please compare each room's acreage firstly and compare the open state of valves for the distributors. Please set a suitable temperature. Please exhaust all the air in the pipe.
<i>No hot water (or hot water isn't hot)</i>	Is the temperature set too low? Are there several places using water? Is there leakage in the hot water pipe? Is the water supply pressure too low? Is the valve for water supply close?	Please set a suitable temperature. Please close excessive taps. Please mend the places where leak. Please take some measures (such as add a raising-pressure pump) when the water pressure is less than 0.02 MPa(0.2bar). Please open the valve for water supply.



TECHNICAL DATA

STYLE		L1PB20-R6	L1PB26-R6	L1PB32-R6	L1PB36-R6	L1PB40-R6
POWER						
Maximum heat input	kW	20.0	26.4	31.5	36.0	40.0
Minimum heat input	kW	7.0	9.2	11.0	12.6	14.0
Maximum heat output	kW	18.0	24.0	28.0	32.0	36.0
Minimum heat output	kW	6.0	7.6	9.2	10.6	11.6
EFFICIENCY						
Efficiency (100% of Nom. Power)	%			≥89		
Efficiency (30% of Nom. Power)	%			≥85		
TECHNICAL PARAMETERS						
NG consumption	m ³ /h	2.12	2.79	3.33	3.81	4.23
Preventing-frostbite system's start temperature	°C	5			5	
Minimum effluent volume of D.H.W.	kg/min	2.5			2.5	
Maximum pressure of D.H.W.	bar	8			8	
Minimum pressure of D.H.W.	bar	0.2			0.2	
Expansion vessel capacity	L	6			8	
Expansion vessel preload capacity	bar	1			1	
Maximum heating system pressure	bar	3			3	
NG pressure	mbar	20			20	
PERFORMANCE						
Maximum heating water temperature	°C	80			80	
Minimum heating water temperature	°C	30			30	
Maximum D.H.W. temperature	°C	60			60	
Minimum D.H.W. temperature	°C	30			30	
D.H.W. flowing rate (Δ t=25 K)	kg/min	10.2	13.4	16.0	18.3	20.4
D.H.W. flowing rate (Δ t=30 K)	kg/min	8.3	10.8	13.3	14.8	16.7
CIRCUIT						
Voltage/frequency	V~/Hz	220/50	220/50	220/50	220/50	220/50
Input electricity power	W	100	120	130	150	150
Electric insulation degree		IPX4D	IPX4D	IPX4D	IPX4D	IPX4D

APPEARANCE AND DIMENSION

unit:mm

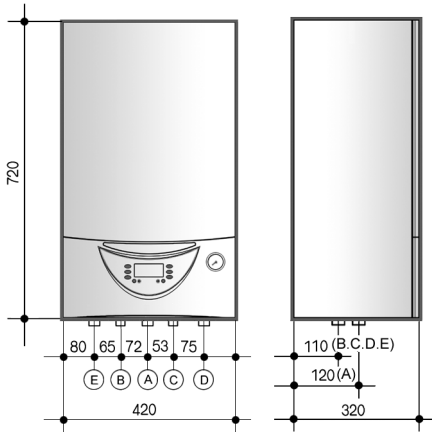

- **L1PB20-R6**
- **L1PB26-R6**

- A.** Gas Inlet
 - B.** D.H.W. Outlet
 - C.** C.W. Inlet
 - D.** B.F.W. Inlet
 - E.** W.O.H. Outlet
- D.H.W.=Domestic Hot Water
C.W.=Cold Water
B.F.W.=Back Flow Water
W.O.H.=Water Of Heating

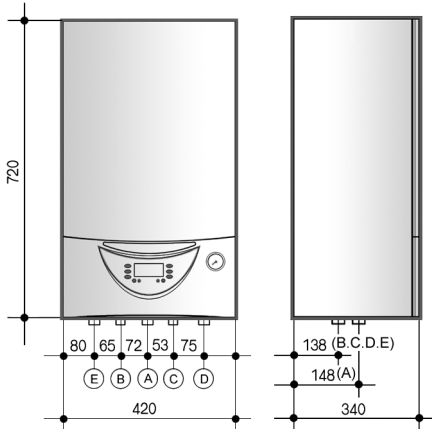

- **L1PB32-R6**
- **L1PB36-R6**
- **L1PB40-R6**

- A.** Gas Inlet
 - B.** D.H.W. Outlet
 - C.** C.W. Inlet
 - D.** B.F.W. Inlet
 - E.** W.O.H. Outlet
- D.H.W.=Domestic Hot Water
C.W.=Cold Water
B.F.W.=Back Flow Water
W.O.H.=Water Of Heating



APPENDIX

Packing List in A Whole Unit

- 1.Host machine
- 2.Installation bag
 - Two pothooks
 - Two expansion bolts (used for fix the pothook)
- 3.Accessory bag
 - One user's guide

Notice:

Due to the improvement of the product, some contents and illustrations in this manual may not be completely consistent with the product without prior notice. please understand that the product specification shall be subject to the product nameplate.

